

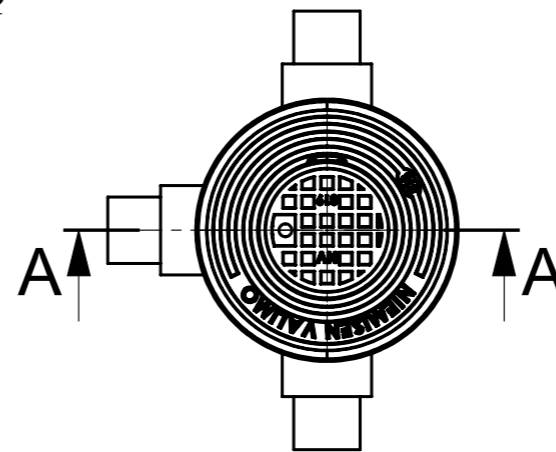

Salajoakaivo SOK 315

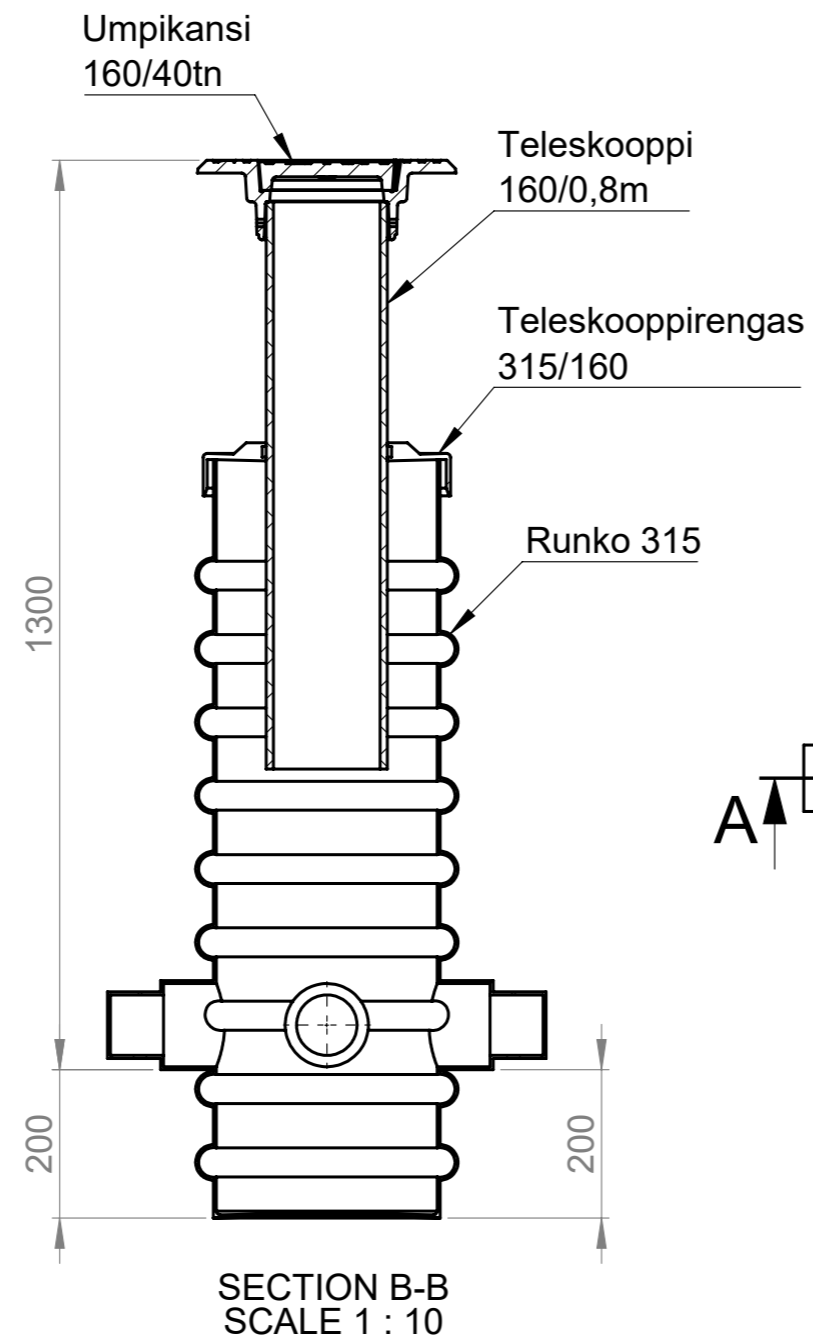
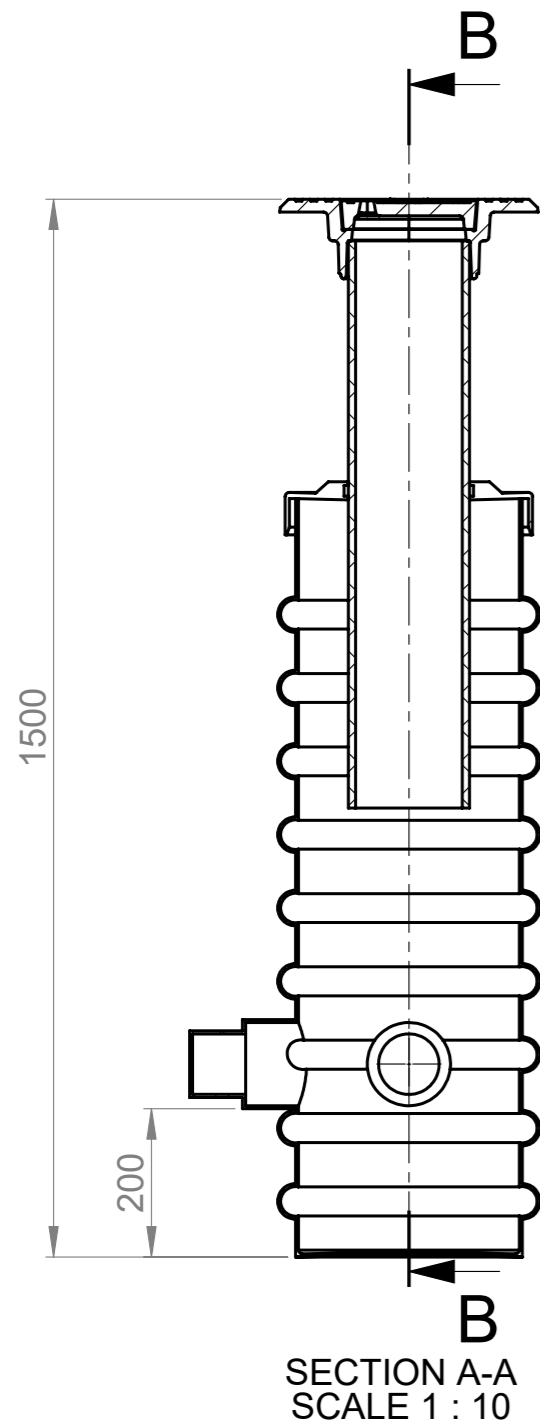

Materiaali:	Rakennustoimenpide: Tyypikuva	Suunnittelija / Piirtäjä: SR	Pvm: 17.11.2020
 Työnumero:	Rakennuskohteen nimi ja osoite:	Massa:	Sivu: 1/1
 www.pipelife.com	Kuvaukset / Sisältö: Salajoakaivo SOK 315	Arkkikoko: A3	Mittakaava: 1:20
		Tuotenumero: 1987	Rev